

# JVC

# SERVICE MANUAL

## COLOR TELEVISION

### AV-27230/IS

### AV-27230/R

BASIC CHASSIS
FD

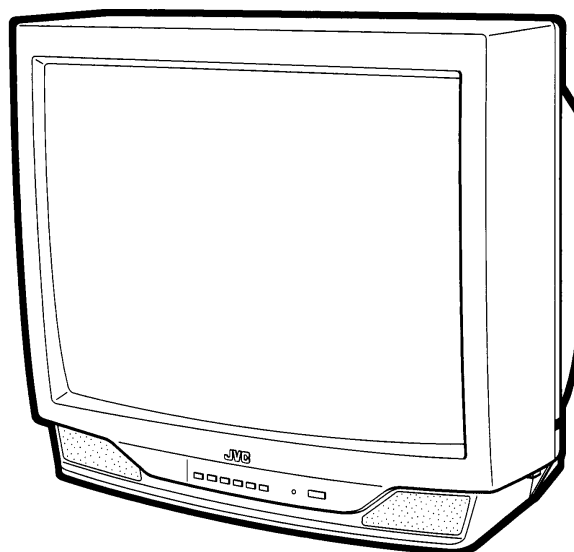
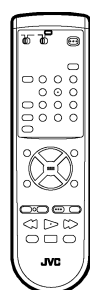

## CONTENTS

■ SPECIFICATIONS .....	2
■ SAFETY PRECAUTIONS .....	3
■ FEATURES .....	4
■ MAIN DIFFERENCE LIST .....	4
■ HOW TO IDENTIFY MODELS .....	4
■ FUNCTIONS .....	5
■ SPECIFIC SERVICE INSTRUCTIONS .....	6
■ SERVICE ADJUSTMENTS .....	10
■ PARTS LIST .....	29
★ OPERATING INSTRUCTIONS .....	1-1
★ STANDARD CIRCUIT DIAGRAM .....	2-1

# SPECIFICATIONS

Items	Contents	
	AV-27230/S AV-27230/R	
<b>Dimensions (W × H × D)</b>	25-3/4" × 23-3/8" × 19-1/2" / 654mm × 593mm × 494mm	
<b>Mass</b>	68.5 lbs / 31.1 kg	
<b>Reception Format</b>	NTSC, BTSC System (Multi-Channel Sound)	
<b>Reception Range</b> VHF, UHF	<b>VL Band</b> (02~06) 54MHz~88MHz <b>VH Band</b> (07~13) 174MHz~216MHz <b>UHF Band</b> (14~69) 470MHz~806MHz	
<b>CATV</b>	<b>Low Band</b> (02~06, A-8) by (02~06&01) <b>High Band</b> (07~13) by (07~13) <b>Mid Band</b> (A~1) by (14~22) <b>Super Band</b> (J~W) by (23~36) <b>Hyper Band</b> (W+1~W+28) by (37~64) <b>Ultra Band</b> (W+29~W+84) by (65~125) <b>Sub Mid Band</b> (A8, A4~A1) by (01, 96~99)	
<b>TV/CATV Total Channel</b>	181 Channels	
<b>Intermediate Frequency</b>	<b>Video IF Carrier</b> 45.75MHz <b>Sound IF Carrier</b> 41.25MHz (4.5MHz)	
<b>Color Sub Carrier</b>	3.58MHz	
<b>Power Input</b>	120V AC, 60Hz	
<b>Power Consumption</b>	113W	
<b>Picture Tube</b>	27" (68cm) Measured Diagonally	
<b>High Voltage</b>	29kV ± 1kV (at zero beam current)	
<b>Speaker</b>	2" × 3-1/2" / 5 × 9cm Oval type × 2	
<b>Audio Power Output</b>	1.2W + 1.2W	
<b>Input terminal</b>		
<b>Input 1</b>	<b>S-Video</b>	Y: 1Vp-p Positive (negative sync provided, when terminated with 75 Ω) C: 0.286Vp-p (burst signal, when terminated with 75 Ω)
	<b>Video(V)</b>	1Vp-p, 75 Ω (RCA pin jack)
	<b>Audio(L, R)</b>	500mVrms ( -4dBs ), High Impedance (RCA pin jack)
<b>Input 2</b>	<b>Component Video</b>	
	Y, Pb, Pr	1Vp-p 75 Ω (positive sync)
<b>Input 3</b> (Front)	<b>Video(V)</b>	1Vp-p, 75 Ω (RCA pin jack)
	<b>Audio(L, R)</b>	500mVrms ( -4dBs ), High Impedance (RCA pin jack)
<b>Output terminal</b>		
<b>Variable Audio Output (R/L)</b>	More than 0~1550mVrms (+6dBs) Low impedance (400Hz when modulated 100%) (RCA pin jack)	
<b>Antenna terminal</b>	75 Ω (VHF/UHF) Terminal, F-Type Connector	
<b>Remote Control Unit</b>	RM-C306-1A (AA/R6/UM-3 battery × 2)	

(54MHz~804MHz)

Design & specifications are subject to change without notice.

# SAFETY PRECAUTIONS

- The design of this product contains special hardware, many circuits and components specially for safety purposes. For continued protection, no changes should be made to the original design unless authorized in writing by the manufacturer. Replacement parts must be identical to those used in the original circuits. Service should be performed by qualified personnel only.
- Alterations of the design or circuitry of the products should not be made. Any design alterations or additions will void the manufacturer's warranty and will further relieve the manufacturer of responsibility for personal injury or property damage resulting therefrom.
- Many electrical and mechanical parts in the products have special safety-related characteristics. These characteristics are often not evident from visual inspection nor can the protection afforded by them necessarily be obtained by using replacement components rated for higher voltage, wattage, etc. Replacement parts which have these special safety characteristics are identified in the parts list of Service manual. **Electrical components having such features are identified by shading on the schematics and by (Δ) on the parts list in Service manual.** The use of a substitute replacement which does not have the same safety characteristics as the recommended replacement part shown in the parts list of Service manual may cause shock, fire, or other hazards.
- Use isolation transformer when hot chassis.**  
The chassis and any sub-chassis contained in some products are connected to one side of the AC power line. An isolation transformer of adequate capacity should be inserted between the product and the AC power supply point while performing any service on some products when the HOT chassis is exposed.
- Don't short between the LIVE side ground and ISOLATED (NEUTRAL) side ground or EARTH side ground when repairing.**  
Some model's power circuit is partly different in the GND. The difference of the GND is shown by the LIVE : (⊥) side GND, the ISOLATED(NEUTRAL) : (↵) side GND and EARTH : (⊕) side GND. Don't short between the LIVE side GND and ISOLATED(NEUTRAL) side GND or EARTH side GND and never measure with a measuring apparatus (oscilloscope etc.) the LIVE side GND and ISOLATED(NEUTRAL) side GND or EARTH side GND at the same time.  
If above note will not be kept, a fuse or any parts will be broken.
- If any repair has been made to the chassis, it is recommended that the B1 setting should be checked or adjusted (See ADJUSTMENT OF B1 POWER SUPPLY).
- The high voltage applied to the picture tube must conform with that specified in Service manual. Excessive high voltage can cause an increase in X-Ray emission, arcing and possible component damage, therefore operation under excessive high voltage conditions should be kept to a minimum, or should be prevented. If severe arcing occurs, remove the AC power immediately and determine the cause by visual inspection (incorrect installation, cracked or melted high voltage harness, poor soldering, etc.). To maintain the proper minimum level of soft X-Ray emission, components in the high voltage circuitry including the picture tube must be the exact replacements or alternatives approved by the manufacturer of the complete product.
- Do not check high voltage by drawing an arc. Use a high voltage meter or a high voltage probe with a VTVM. Discharge the picture tube before attempting meter connection, by connecting a clip lead to the ground frame and connecting the other end of the lead through a 10kΩ 2W resistor to the anode button.
- When service is required, observe the original lead dress. Extra precaution should be given to assure correct lead dress in the high voltage circuit area. Where a short circuit has occurred, those components that indicate evidence of overheating should be replaced. Always use the manufacturer's replacement components.

## 10. Isolation Check

### (Safety for Electrical Shock Hazard)

After re-assembling the product, always perform an isolation check on the exposed metal parts of the cabinet (antenna terminals, video/audio input and output terminals, Control knobs, metal cabinet, screwheads, earphone jack, control shafts, etc.) to be sure the product is safe to operate without danger of electrical shock.

#### (1) Dielectric Strength Test

The isolation between the AC primary circuit and all metal parts exposed to the user, particularly any exposed metal part having a return path to the chassis should withstand a voltage of 1100V AC (r.m.s.) for a period of one second.

(. . . Withstand a voltage of 1100V AC (r.m.s.) to an appliance rated up to 120V, and 3000V AC (r.m.s.) to an appliance rated 200V or more, for a period of one second.)

This method of test requires a test equipment not generally found in the service trade.

#### (2) Leakage Current Check

Plug the AC line cord directly into the AC outlet (do not use a line isolation transformer during this check.). Using a "Leakage Current Tester", measure the leakage current from each exposed metal part of the cabinet, particularly any exposed metal part having a return path to the chassis, to a known good earth ground (water pipe, etc.). Any leakage current must not exceed 0.5mA AC (r.m.s.).

However, in tropical area, this must not exceed 0.2mA AC (r.m.s.).

#### ● Alternate Check Method

Plug the AC line cord directly into the AC outlet (do not use a line isolation transformer during this check.). Use an AC voltmeter having 1000 ohms per volt or more sensitivity in the following manner. Connect a 1500Ω 10W resistor paralleled by a 0.15μF AC-type capacitor between an exposed metal part and a known good earth ground (water pipe, etc.). Measure the AC voltage across the resistor with the AC voltmeter. Move the resistor connection to each exposed metal part, particularly any exposed metal part having a return path to the chassis, and measure the AC voltage across the resistor. Now, reverse the plug in the AC outlet and repeat each measurement. Any voltage measured must not exceed 0.75V AC (r.m.s.). This corresponds to 0.5mA AC (r.m.s.). However, in tropical area, this must not exceed 0.3V AC (r.m.s.). This corresponds to 0.2mA AC (r.m.s.).

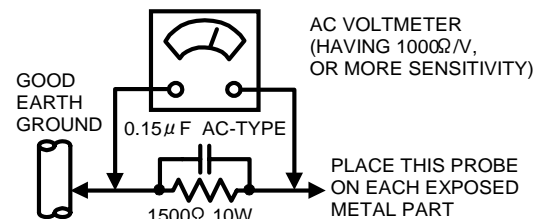

## 11. High voltage hold down circuit check.

After repair of the high voltage hold down circuit, this circuit shall be checked to operate correctly.

See item "How to check the high voltage hold down circuit".

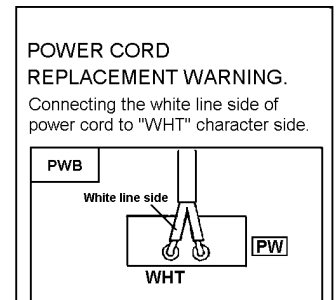
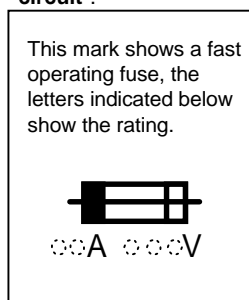

# FEATURES

- New chassis design enables use of a single board with simplified circuitry.
- Users can make fun to connect the Digital Video Disk player with the component video signal input terminal.
- Provided with miniature tuner (TV/CATV).
- Multifunctional remote control permits picture adjustment.
- Adoption of the CHANNEL GUARD function prevents the specific channels from being selected, unless the "ID number" is key in.
- I<sup>2</sup>C bus control utilizes single chip ICs.
- Adoption of the VIDEO STATUS function.
- Adoption of the ON/OFF TIMER function.
- Built-in V-CHIP system.
- With 75 Ω V/U in common (F-Type) ANT Terminal.
- SLEEP TIMER for setting in real time.
- Closed-caption broadcasts can be viewed.
- Built-in MTS system.
- Built-in HYPER-SURROUND system.
- S-VIDEO input terminal for taking best advantage of Super VHS.
- Variable Audio output terminal.
- 2 LINE Digital Comb filter Improved picture quality.

# MAIN DIFFERENCE LIST

⚠	Model name	AV-27230/S	AV-27230/R
	Parts Name		
	MAIN PWB	SFD-1003A-M2	SFD-1004A-M2
⚠	ITC TUBE	A68QDN891X001	A68ADT25X01

# HOW TO IDENTIFY MODELS

The difference between AV-27230/S and AV-27230/R is in the PICTURE TUBE.  
As the result of the difference in picture tube, the MAIN PWB also differs.

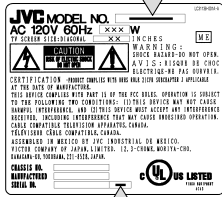
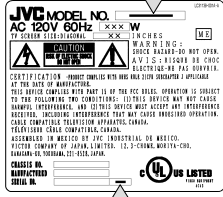
⚠	MODEL	AV-27230/S	AV-27230/R
	Parts name		
⚠	RATING LABEL	LC31139-001A-A	←
		<p>Indicated AV-27230</p>  <p>Indicated "S"</p>	<p>Indicated AV-27230</p>  <p>Indicated "R"</p>

# FUNCTIONS

## FRONT PANEL CONTROL

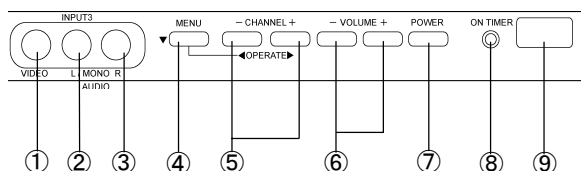

- ① VIDEO INPUT TERMINAL
- ② AUDIO L INPUT TERMINAL
- ③ AUDIO R INPUT TERMINAL
- ④ MENU KEY
- ⑤ CHANNEL +/- KEY (OPERATE KEY)
- ⑥ VOLUME +/- KEY
- ⑦ POWER LED
- ⑧ ON TIMER LED
- ⑨ REMOCON WINDOW

## REAR TERMINAL

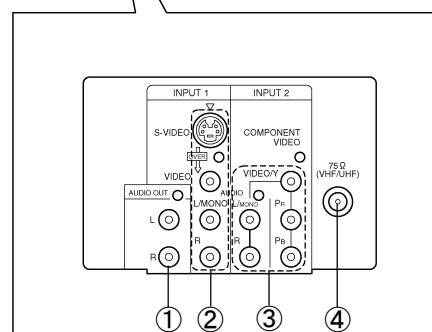
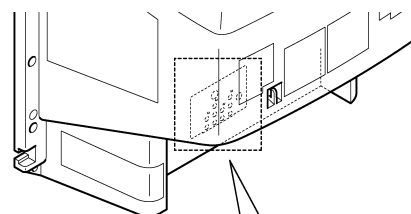

- ① AUDIO OUTPUT TERMINAL
- ② INPUT1 TERMINAL(S, V, L, R)
- ③ INPUT2 TERMINAL(V/Y, PR, PB, L, R)
- ④ AERIAL SOCKET

## REMOTE CONTROL UNIT [RM-C306]

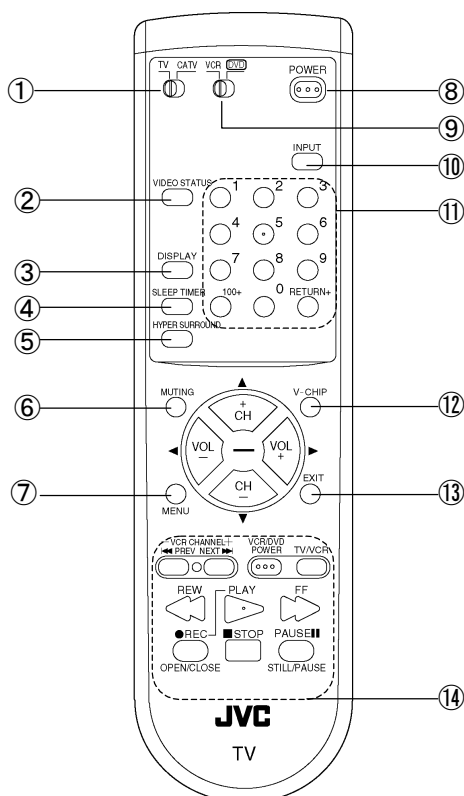

- ① TV / CATV
- ② VIDEO STATUS
- ③ DISPLAY
- ④ SLEEP TIMER
- ⑤ HYPER SURROUND
- ⑥ MUTING
- ⑦ MENU
- ⑧ POWER
- ⑨ VCR / DVD
- ⑩ INPUT
- ⑪ CHANNEL KEYS
- ⑫ V-CHIP
- ⑬ EXIT
- ⑭ VCR CONTROL KEYS

# SPECIFIC SERVICE INSTRUCTIONS

## DISASSEMBLY PROCEDURE

### REMOVING THE REAR COVER

1. Disconnect the power plug from wall outlet.
2. As shown in the Fig.1, remove the **7** screws marked **(A)** .
3. As shown in Fig.1, remove the **4** screws marked **(B)** .
4. Then remove the REAR COVER toward you.

### REMOVING THE MAIN PWB

- After removing the REAR COVER.
1. Slightly raise the both sides of the Main PWB by hand and remove the Main PWB from the front cabinet.
  2. Withdraw the chassis backward.  
(If necessary, remove the wire clamp, connectors etc.)

### REMOVING THE SPEAKER

- After removing the rear cover.
1. As shown in Fig. 1, removing the **2** screws marked **(C)** , then remove the speaker.
  2. Follow the same steps when removing the other hand speaker.

### CHECKING THE PW BOARD

To check the PW Board from back side.

1. Pull out the chassis (refer to REMOVING THE MAIN PWB).
2. Erect the chassis vertically so that you can easily check the back side of the PW Board.

### CAUTION

- When erecting the chassis, be careful so that there will be no contacting with other PW Board.
- Before turning on power, make sure that the wire connector is properly connected.
- **When conducting a check with power supplied, be sure to confirm that the CRT EARTH WIRE (BRAIDED ASS' Y) is connected to the CRT SOCKET PW board.**

### WIRE CLAMPING AND CABLE TYING

1. Be sure to clamp the wire.
2. Never remove the cable tie used for tying the wires together.  
Should it be inadvertently removed, be sure to tie the wires with a new cable tie.

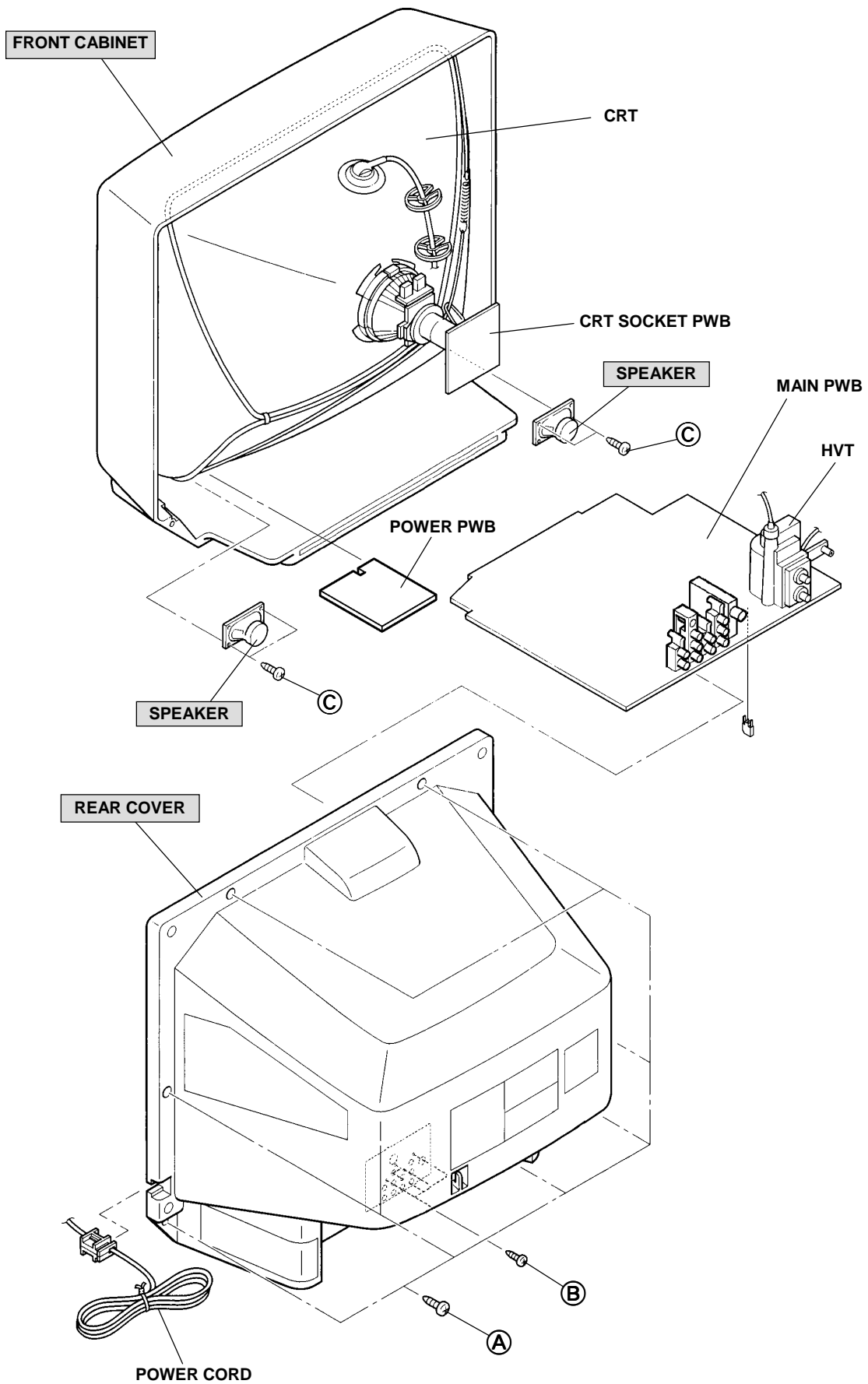

Fig.1

# MEMORY IC REPLACEMENT

## 1. Memory IC

This model uses a memory IC.

This memory IC stores data for proper operation of the video and deflection circuits.

When replacing, be sure to use an IC containing this (initial value) data.

## 2. Memory IC replacement procedure

Procedure	Screen display
<p><b>(1) Power off</b> Switch off the power and disconnect the power cord from the outlet.</p>	
<p><b>(2) Replace the memory IC</b> Initial value must be entered into the new IC.</p>	
<p><b>(3) Power on</b> Connect the power cord to the outlet and switch on the power.</p>	
<p><b>(4) System constant check and setting</b></p> <ol style="list-style-type: none"> <li>1) Press <b>SLEEP TIMER</b> key and, while the indication of "<b>SLEEP TIMER 0 MIN.</b>" is being displayed, press <b>DISPLAY</b> key and <b>VIDEO STATUS</b> key on the remote control unit simultaneously.</li> <li>2) The SERVICE MENU screen of Fig.1 is displayed.</li> <li>3) While the SERVICE MENU is displayed, again simultaneously press the <b>DISPLAY</b> and <b>VIDEO STATUS</b> keys to display the Fig.2 SYSTEM CONSTANT screen.</li> <li>4) Refer to the SYSTEM CONSTANT table and check the setting items. Where these differ, select the setting item with the <b>UP/DOWN (▲/▼)</b> key and adjust the setting with the <b>LEFT/RIGHT (◀/▶)</b> keys.</li> <li>5) After adjusting, release the <b>LEFT/RIGHT(◀/▶)</b> key to store the setting value.</li> <li>6) Press the <b>EXIT</b> key twice to return the normal screen.</li> </ol>	 <p style="text-align: center;">Fig.1</p>
<p><b>(5) Receive channel setting</b> Refer to the OPERATING INSTRUCTIONS (USER'S GUIDE) and set the receive channels (Channels Preset) as described.</p>	
<p><b>(6) User settings</b> Check the user setting items according to Table 2. Where these do not agree, refer to the OPERATING INSTRUCTIONS (USER'S GUIDE) and set the items as described.</p>	 <p style="text-align: center;">Fig.2</p>
<p><b>(7) SERVICE MENU setting</b> Verify what to set in the SERVICE MENU, and set whatever is necessary.(Fig.1) Refer to the SERVICE ADJUSTMENT for setting.</p>	



TABLE 1 (System Constant setting)

Setting item	Setting content	Setting value	
		AV-27230/S	AV-27230/R
MODEL		AV-27230	AV-27230
V-CHIP		YES	YES
CAN V-CHIP		YES	YES

TABLE 2 (User setting value)

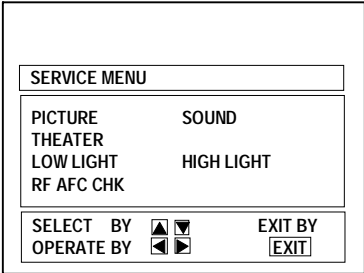
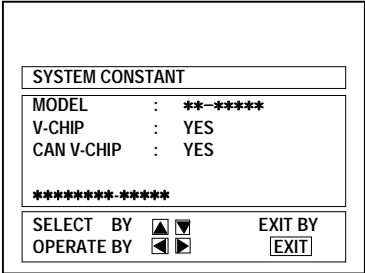
Setting item	Setting value
1. Use remote controller keys	
POWER	ON
CHANNEL	CH 02
CHANNEL PRESET	See OPERATING INSTRUCTIONS.
VOLUME	10
TV/VIDEO(INPUT)	TV
DISPLAY	OFF
SLEEP TIMER	OFF
VIDEO STATUS	STANDARD
HYPER SURROUND	OFF
2. Setting of MENU	
TINT	CENTER
COLOR	CENTER
PICTURE	CENTER
BRIGHT	CENTER
DETAIL	CENTER
NOISE MUTING	ON
SET VIDEO STATUS	ALL CENTER
BASS	CENTER
TREBLE	CENTER
BALANCE	CENTER
MTS	STEREO
TV SPEAKER	ON
SET CLOCK	Unnecessary to set
ON/OFF TIMER	NO
LANGUAGE	ENGLISH
CLOSED CAPTION	OFF
BACKGROUND	BLACK
V2 COMPONENT IN	NO
AUTO TUNER SETUP	TUNER MODE : AIR
CHANNEL SUMMARY	Unnecessary to set
V-CHIP	OFF
V-CHIP RATINGS	ALL OFF
SET LOCK CODE	Unnecessary to set
UNRATED	VIEW

# SERVICE ADJUSTMENTS

## ADJUSTMENT PREPARATION

1. You can make the necessary adjustments for this unit with either the Remote Control Unit or with the adjustment tools and parts as given below.
2. Adjustment with the Remote Control Unit is made on the basis of the initial setting values, however, the new setting values which set the screen to its optimum condition may differ from the initial settings.
3. Make sure that AC power is turned on correctly.
4. Turn on the power for set and test equipment before use, and start the adjustment procedures after waiting at least 30 minutes.
5. Unless otherwise specified, prepare the most suitable reception or input signal for adjustment.
6. Never touch any adjustment parts which are not specified in the list for this adjustment - variable resistors, transformers, condensers, etc.

7. Presetting before adjustment.  
Unless otherwise specified in the adjustment instructions, preset the following functions with the remote control unit:

VIDEO STATUS	STANDARD
BASS, TREBLE, BALANCE	CENTER
HYPERSURROUND	OFF
TINT, COLOR, PICTURE, BRIGHT, DETAIL	CENTER

## ADJUSTMENT EQUIPMENT

1. DC voltmeter (or digital voltmeter)
2. Oscilloscope
3. Signal generator (Pattern generator) [NTSC]
4. Remote control unit
5. TV audio multiplex signal generator.
6. Frequency counter

## ADJUSTMENT ITEMS

Adjustment items	Adjustment items	Adjustment items
B1 POWER SUPPLY	WHITE BALANCE (High Light)	MTS STEREO VCO
RF. AGC	SUB BRIGHT	MTS SAP VCO
FOCUS	SUB CONTRAST	MTS FILTER check
V. SIZE	SUB COLOR	MTS SEPARATION
H. POSITION	SUB TINT	
WHITE BALANCE (Low Light)	MTS INPUT LEVEL check	

# ADJUSTMENT LOCATIONS

**CRT SOCKET PWB**  
(Within MAIN PWB ASS'Y)

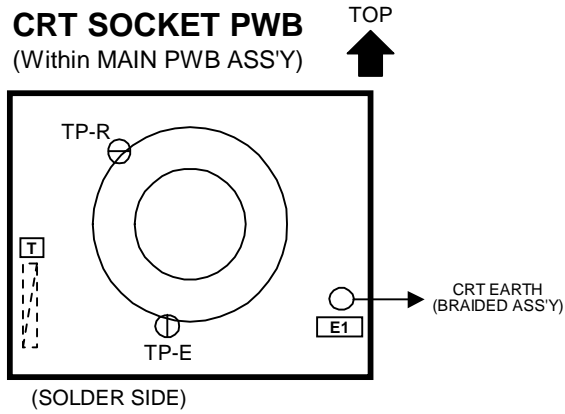

**POWER PWB**

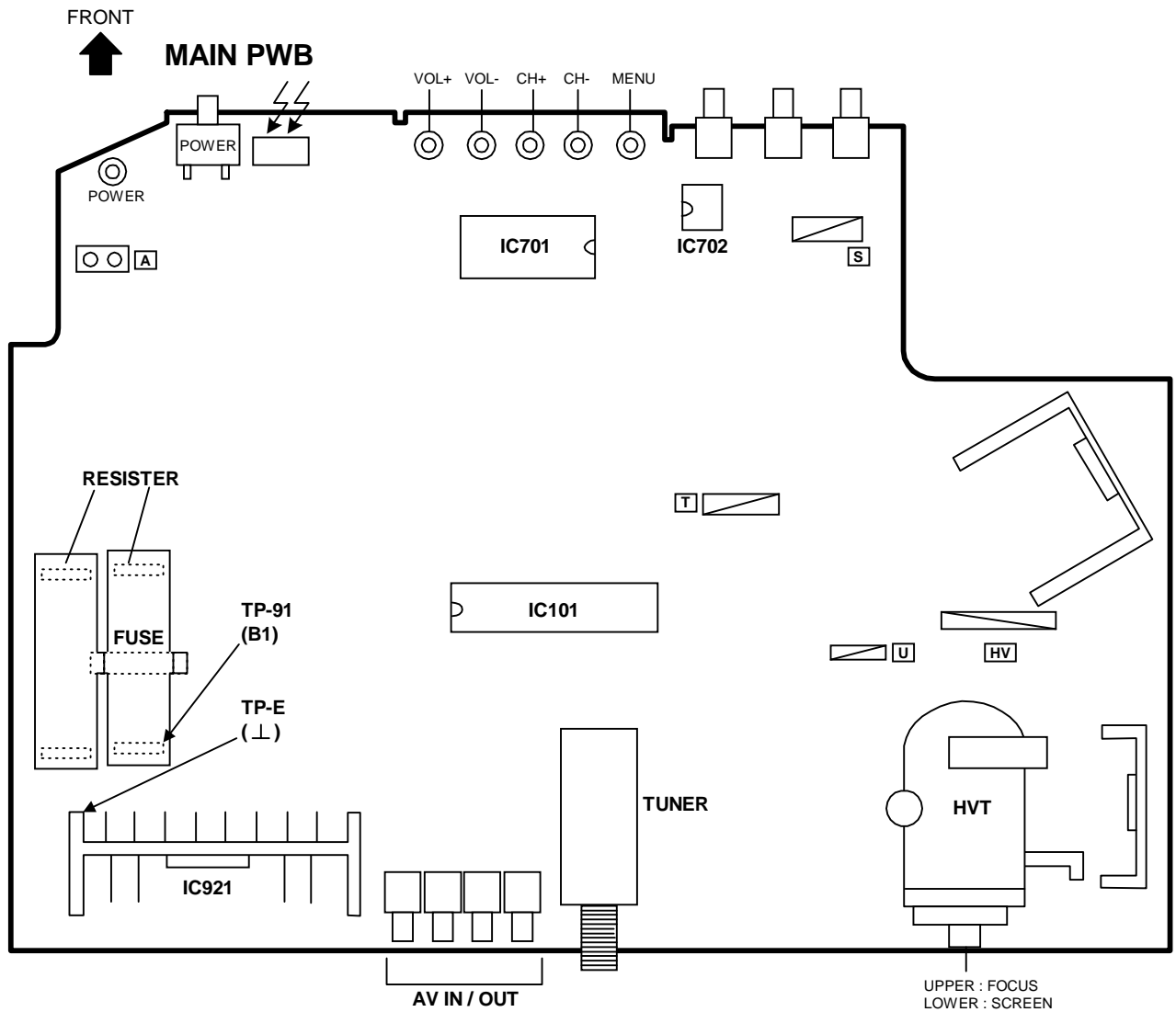
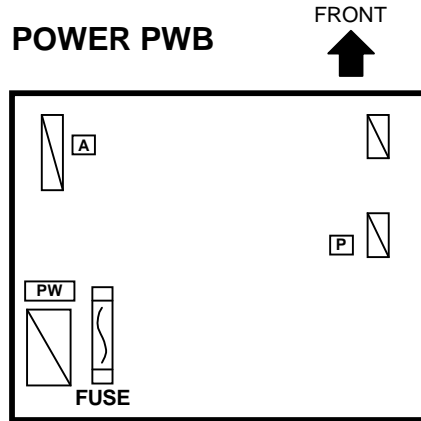

## BASIC OPERATION OF SERVICE MENU

### 1. TOOL OF SERVICE MENU OPERATION

Operate the SERVICE MENU with the REMOTE CONTROL UNIT.

### 2. SERVICE MENU ITEMS

In general, basic setting (adjustments) items or verifications are performed in the SERVICE MENU.

- PICTURE ..... This sets the setting values (adjustment values) of the VIDEO/CHROMA and DEFLECTION circuits.
- SOUND ..... This sets the setting values (adjustment values) of the AUDIO circuit.
- THEATER ..... This is used when the THEATER MODE is adjusted.
- LOW LIGHT ..... This sets the setting values (adjustment values) of the WHITE BALANCE circuit.
- HIGH LIGHT ..... This sets the setting values (adjustment values) of the WHITE BALANCE circuit.
- RF AFC CHK ..... This is used when the IF VCO is adjusted. **[Do not adjust]**

### 3. Basic Operations of the SERVICE MENU

#### (1) How to enter the SERVICE MENU.

Press **SLEEP TIMER** key and, while the indication of "SLEEP TIMER 0 MIN." is being displayed, press **DISPLAY** key and **VIDEO STATUS** key on the remote control unit simultaneously to enter the **SERVICE MENU** screen ① shown in the next figure page.

#### (2) SERVICE MENU screen selection

Press the **UP / DOWN(▲/▼)** key to select any of the following items.

- PICTURE
- THEATER
- LOW LIGHT
- RF AFC CHK
- SOUND
- HIGH LIGHT

#### (3) Enter the any setting ( adjustment ) mode

##### ● PICTURE and SOUND mode

- 1) If select any of PICTURE or SOUND items, and the **LEFT / RIGHT(◀/▶)** key is pressed from SERVICE MENU ( MAIN MENU ), the screen ② will be displayed as shown in figure page later.
- 2) Then the **UP / DOWN(▲/▼)** key is pressed, the PICTURE mode screen ③ or the SOUND mode screen ④ is displayed, and the PICTURE or SOUND setting can be performed.

##### ● THEATER, LOW LIGHT, HIGH LIGHT and RF AFC CHK mode

- 1) If select any of THEATER / LOW LIGHT / HIGH LIGHT / RF AFC CHK items, and the **LEFT / RIGHT(◀/▶)** key is pressed from SERVICE MENU ( MAIN MENU ), the screens ⑤ ⑥ ⑦ ⑧ will be displayed as shown in figure page later.
- 2) Then the settings or verifications can be performed.

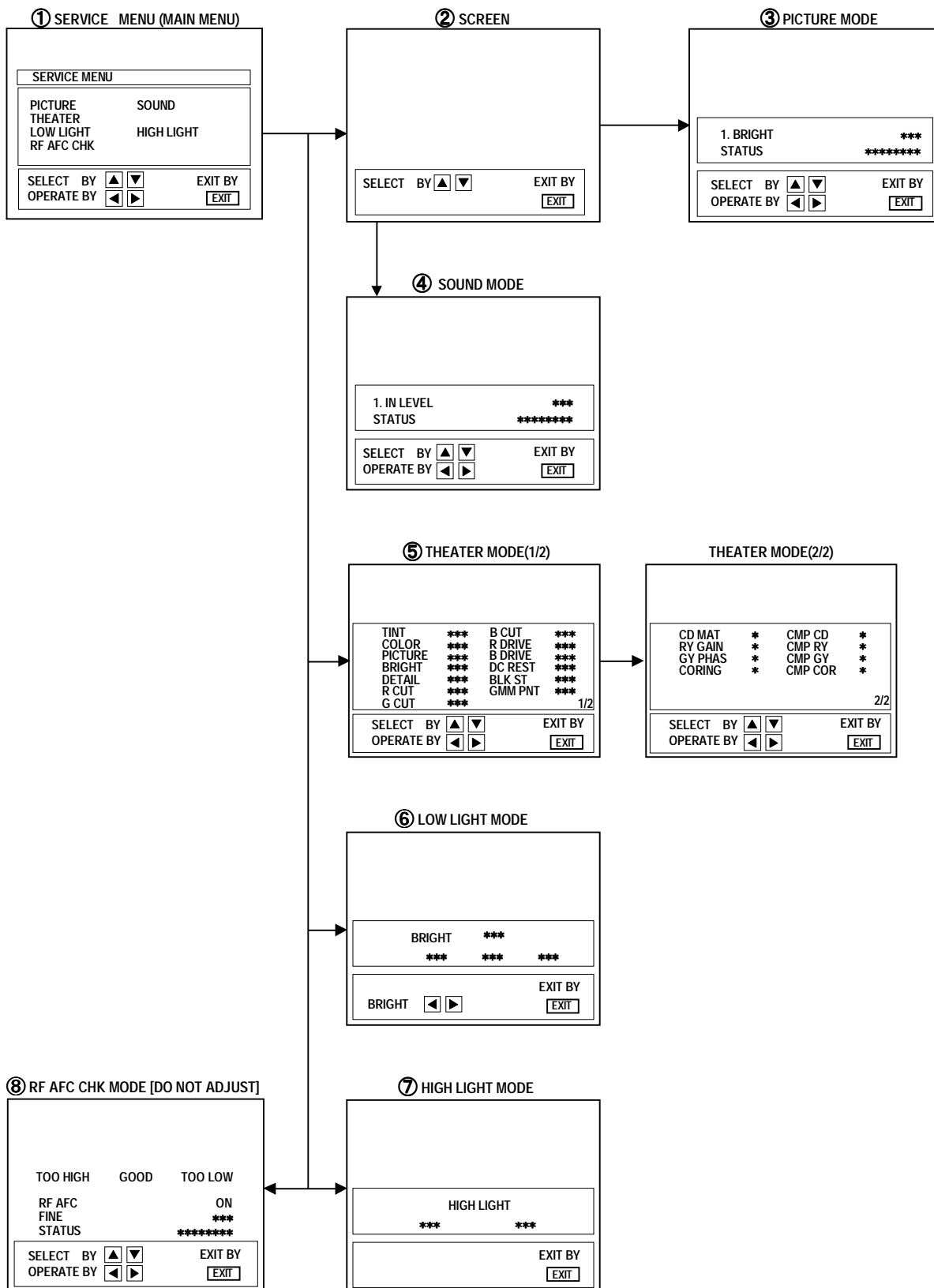

**(4) Setting method**

- 1) **UP / DOWN (▲/▼)**key.  
Select the SETTING ITEM.
- 2) **LEFT / RIGHT(◀/▶)** key.  
Setting (adjust) the SETTING VALUE of the SETTING ITEM.  
When the key is released the SETTING VALUE will be stored (memorized).
- 3) **EXIT** key  
Return to the previous screen.

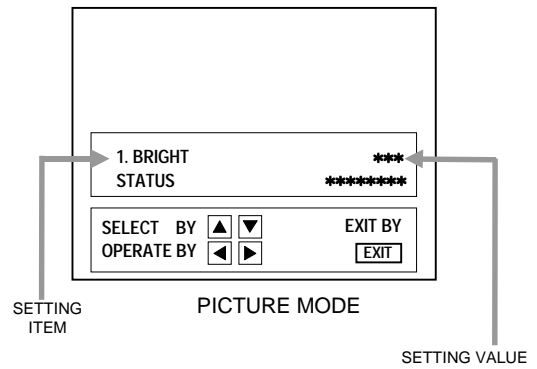

**(5) Releasing SERVICE MENU**

- 1) After returning to the SERVICE MENU upon completion of the setting (adjustment) work, press the EXIT key again.

★ The settings for LOW LIGHT and HIGH LIGHT are described in the WHITE BALANCE page of ADJUSTMENT.

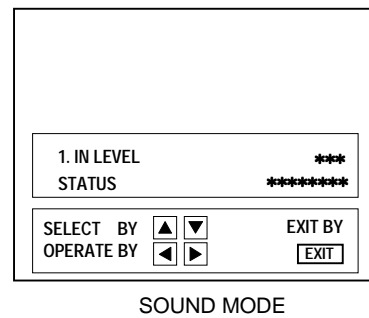

(The letter of the selected items are displayed in yellow.)

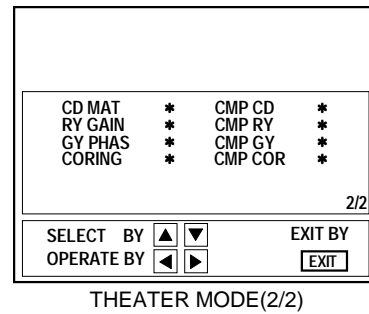
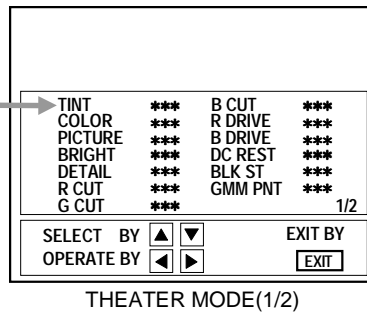

## INITIAL SETTING VALUE OF SERVICE MENU

1. Adjustment of the SERVICE MENU is made on the basis of the initial setting values; however, the new setting values which set the screen in its optimum condition may differ from the initial setting.
2. Do not change the initial setting values of the setting (adjustment) items not listed in "ADJUSTMENT".

### PICTURE MODE

- The 5 setting items in the video mode No.6 EXT BRI, No.7 EXT PICT, No.8 EXT CLR, No.9 EXT TINT and No.10 EXT DTL are linked to the items in the TV MODE No.1 BRIGHT, No.2 PICTURE, No.3 COLOR, No.4 TINT and No.5 TV DTL respectively. When the setting items in the TV mode are adjusted, the values in the setting items in the video mode are revised automatically to the same values in the TV mode. (The initial setting values given in parenthesis are offset values.)
- When the 5 items (No.6, 7, 8, 9 and 10) are adjusted in the video mode, the setting values in each item are changed independently.

No.	Setting (Adjustment) items	Variable range	Initial setting value	
			AV-27230/S	AV-27230/R
1.	BRIGHT	000~127	064	064
2.	PICTURE	000~127	100	100
3.	COLOR	000~127	055	055
4.	TINT	000~127	087	087
5.	TV DTL	000~63	050	050
6.	EXT BRI.	±025	±000	±000
7.	EXT PICT.	±025	+002	+002
8.	EXT CLR	±025	±000	±000
9.	EXT TINT	±025	-005	-005
10.	EXT DTL	000~063	050	050
11.	CMP BRI	±025	-001	-001
12.	CMP PICT	±025	±000	±000
13.	CMP CLR	000~127	072	072
14.	CMP TINT	000~127	037	037
15.	CMP DTL	000~063	050	050
16.	CMP R CT	±025	+008	+008
17.	CMP G CT	±025	±000	±000
18.	CMP B CT	±025	+008	+008
19.	CMP R DR	±025	±000	±000
20.	CMP B DR	±025	-002	-002
21.	WPL	000 / 001	001	001
22.	C TRAP	000 / 001	000	000
23.	CORING	000 / 001	001	001
24.	CMP CORI	000 / 001	001	001
25.	TV SHAP	000 / 001	001	001
26.	EXT SHAP	000 / 001	001	001
27.	CMP SHAP	000 / 001	001	001
28.	RGB CONT	000~063	016	016
29.	TV ID S	000 / 001	000	000
30.	EXT ID S	000 / 001	000	000

No.	Setting (Adjustment) items	Variable range	Initial setting value	
			AV-27230/S	AV-27230/R
31.	F ID	000 / 001	000	000
32.	Y MUTE	000 / 001	000	000
33.	SUB CONT	000~015	008	008
34.	R Y GAIN	000 / 001	001	001
35.	CMP R Y	000 / 001	001	001
36.	G Y PHAS	000 / 001	001	001
37.	CMP G Y	000 / 001	001	001
38.	CD MATRI	000~003	003	003
39.	CMP CD M	000~003	001	001
40.	BLK ST	000~003	001	001
41.	DC REST	000~003	001	001
42.	CLR GMM	000 / 001	000	000
43.	UV / CBCR	000 / 001	000	000
44.	AT FLESH	000 / 001	000	000
45.	ABL GAIN	000~003	000	000
46.	ABL ST P	000~003	003	003
47.	RGB ABCL	000 / 001	001	001
48.	TV B/T	000 / 001	001	001
49.	EXT B/T	000 / 001	000	000
50.	GMM PNT	000~003	003	003
51.	BUZZ	000 / 001	000	000
52.	RF AGC	000~063	045	045
53.	AFT SENS	000 / 001	001	001
54.	R/G DRV	000 / 001	001	001
55.	BLK SW	000 / 001	000	000
56.	V S COR	000~015	011	011
57.	V LIN	000~015	012	012
58.	V SIZE	000~127	037	037
59.	V AGC	000 / 001	000	000
60.	TV AFC	000~003	001	001
61.	EXT AFC	000~003	002	002
62.	V POSI	000~007	000	000
63.	H POSI	000~031	015	015
64.	TV V FR	000~003	000	000
65.	EXT V FR	000~003	003	003
66.	STND BY	000 / 001	000	000
67.	V RMP RE	000 / 001	001	001
68.	V 48HZ	000 / 001	000	000
69.	V EHT	000~007	000	000
70.	H EHT	000~007	000	000



No.	Setting (Adjustment) items	Variable range	Initial setting value	
			AV-27D230/S	AV-27230/R
71.	V BLK L	000~003	000	000
72.	V BLK U	000~003	001	001
73.	CCD IN	000 / 001	000	000
74.	H BLK	000 / 001	000	000
75.	OVER MD	000 / 001	001	001
76.	APACON L	000 / 001	001	001
77.	RF S/N T	000 / 001	000	000
78.	EX S/N T	000 / 001	000	000
79.	R S/N V1	000~063	000	000
80.	R S/N V2	000~063	000	000
81.	R S/N V3	000~063	000	000
82.	R S/N V4	000~063	000	000
83.	E S/N V1	000~063	000	000
84.	E S/N V2	000~063	000	000
85.	E S/N V3	000~063	000	000
86.	E S/N V4	000~063	000	000
87.	COR LEV	000~003	000	000
88.	VNR CHK	000~255	000	000
89.	VC SN TM	000~255	000	000
90.	VC SN SP	000~255	000	000
91.	CH MUTE	000 / 001	000	000
92.	OSD HP	000~031	018	018
93.	OSD VP	000~031	008	008
94.	FM TRAP	000 / 001	000	000
95.	OSC SEL	000 / 001	001	001
96.	SD SEL	000 / 001	001	001
97.	VF LK EX	000 / 001	000	000
98.	F LOCK	000~002	002	002
99.	AFC HIGH	000~064	031	031

## SOUND MODE

No.	Setting (Adjustment) item	Variable range	Initial setting value	
			AV-27230/S	AV-27230/R
1.	IN LEVEL	000~063	024	024
2.	FH MON	000 / 001	000	000
3.	ST VCO	000~063	032	032
4.	PILOT	000 / 001	000	000
5.	FILTER	000~063	027	027
6.	LOW SEP	000~063	014	014
7.	HI SEP	000~063	021	021
8.	5FH MON	000 / 001	000	000
9.	SAP VCO	000~063	034	034
10.	BBE BASS	±010	-001	-001
11.	BBE TRE	±010	-001	-001

## THEATER MODE

Setting (Adjustment) item	Variable range	Initial setting value	
		AV-27230/S	AV-27230/R
TINT	±20	-06	-06
COLOR	±20	-05	-05
PICTURE	±50	-08	-08
BRIGHT	±20	±00	±00
DETAIL	±20	+03	+03
R CUT	±20	±00	±00
G CUT	±20	±00	±00
B CUT	±20	±00	±00
R DRIVE	-99~+99	+06	+06
B DRIVE	-99~+99	-18	-18
DC REST	0~3	+01	+01
BLK ST	0~3	±00	±00
GMM PNT	0~3	+01	+01
CD MAT	0~3	+01	+01
RY GAIN	0~1	+01	+01
GY PHAS	0~1	±00	±00
CORING	0~1	+01	+01
CMP CD	0~3	+01	+01
CMP RY	0~1	+01	+01
CMP GY	0~1	±00	±00
CMP COR	0~1	+01	+01

## LOW LIGHT MODE

Setting (Adjustment) item	Variable range	Initial setting value
R CUTOFF	0~255	85
G CUTOFF	0~255	85
B CUTOFF	0~255	85

## HIGH LIGHT MODE

Setting (Adjustment) item	Variable range	Initial setting value
G DRIVE	0 ~ 255	60
B DRIVE	0 ~ 255	60

## RF AFC CHECK MODE

Setting (Adjustment) item	Variable range	Initial setting value
RF AFC	ON / OFF	ON
FINE	FIXED	FIXED <b>( DO NOT ADJUST )</b>

## ■ ADJUSTMENTS

### B1 POWER SUPPLY

Item	Measuring instrument	Test point	Adjustment part	Description
Check of B1 POWER SUPPLY	DC Voltmeter	TP-91 (B1) TP-E(L)		<ol style="list-style-type: none"> <li>1. Receive a black-and-white signal.</li> <li>2. Connect the DC Voltmeter to TP-91 (B1) and TP-E(L).</li> <li>3. Confirm that the voltage is DC134V<sup>+2V</sup><sub>-2.5V</sub> .</li> </ol>

### ADJUSTMENT OF VIDEO / CHROMA, DEFLECTION CIRCUIT

Item	Measuring instrument	Test point	Adjustment part	Description
RF. AGC adjustment			No.52 RF AGC	<ol style="list-style-type: none"> <li>1. Receive a broadcast.</li> <li>2. Select "No.52 RF AGC" of the PICTURE MODE.</li> <li>3. Press the MUTING key and turn off the color.</li> <li>4. With the MENU LEFT key, get noise in the screen picture. (0 side of setting value)</li> <li>5. Press the MENU RIGHT key and stop when noise disappears from the screen.</li> <li>6. Change to other channels and make sure that there is no irregularity.</li> <li>7. Press the MUTING key and get color out.</li> </ol>
FOCUS adjustment	Signal generator		FOCUS VR [In HVT]	<ol style="list-style-type: none"> <li>1. Receive a crosshatch signal.</li> <li>2. While looking at the screen, adjust FOCUS VR so that the vertical and horizontal lines will be clear and in fine detail.</li> <li>3. Make sure that the picture is in focus even when the screen gets darkened.</li> </ol>

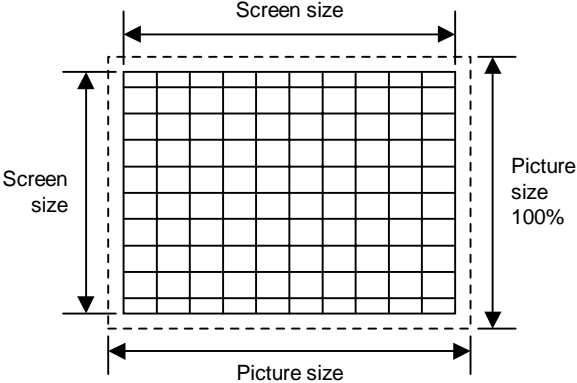
Item	Measuring instruments	Test point	Adjustment part	Description						
<b>V.SIZE Adjustment</b>	<b>Signal generator</b>		<b>No.58 V.SIZE</b>	<ol style="list-style-type: none"> <li>1. Receive a crosshatch signal.</li> <li>2. Select No.58 V.SIZE in the PICTURE MODE.</li> <li>3. Set the initial setting value of No.58 V.SIZE with the LEFT / RIGHT key of the MENU.</li> <li>4. Adjust No.58 V.SIZE until the vertical screen size becomes the value as shown table below.</li> </ol> <table border="1" data-bbox="775 629 1359 904"> <thead> <tr> <th data-bbox="775 629 1050 689">Application model</th> <th data-bbox="1050 629 1359 689">Vertical screen size</th> </tr> </thead> <tbody> <tr> <td data-bbox="775 689 1050 797">AV-27230/S</td> <td data-bbox="1050 689 1359 797">89.0%</td> </tr> <tr> <td data-bbox="775 797 1050 904">AV-27230/R</td> <td data-bbox="1050 797 1359 904">92.0%</td> </tr> </tbody> </table> 	Application model	Vertical screen size	AV-27230/S	89.0%	AV-27230/R	92.0%
Application model	Vertical screen size									
AV-27230/S	89.0%									
AV-27230/R	92.0%									
<b>H.POSITION Adjustment</b>	<b>Signal generator</b>		<b>No.63 H.POSI</b>	<ol style="list-style-type: none"> <li>1. Receive a crosshatch signal.</li> <li>2. Select the No.63 H.POSI of the PICTURE MODE.</li> <li>3. Set the initial setting value of the No.63 H.POSI with the LEFT / RIGHT key of the MENU.</li> <li>4. Adjust the No.63 H.POSI until the screen will be horizontally centered.</li> </ol>						

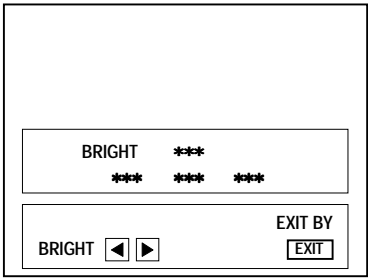
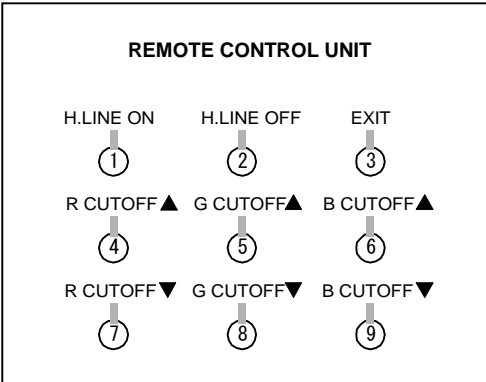
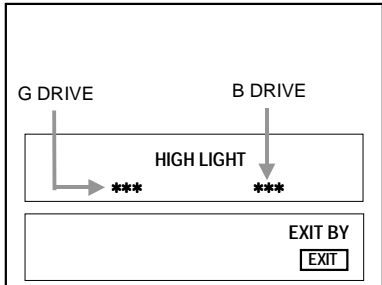
Item	Measuring instruments	Test point	Adjustment part	Description														
<p><b>WHITE BALANCE (Low Light) Adjustment</b></p>	<p>Signal generator</p>		<p><b>BRIGHT</b></p> <p><b>R. CUTOFF</b> <b>G. CUTOFF</b> <b>B. CUTOFF</b></p> <p><b>SCREEN VR [In HVT]</b></p>	<ol style="list-style-type: none"> <li>1. Receive a black-and-white signal.(Color off)</li> <li>2. Select the LOW LIGHT MODE from the SERVICE MENU.</li> <li>3. Set the initial setting value of BRIGHT with the LEFT / RIGHT key of the remote control unit.</li> <li>4. Set the initial setting value of R CUTOFF, G CUTOFF and B CUTOFF with the ④or⑦key(R), ⑤or⑧key(G), ⑥or⑨key(B) of the remote control unit.</li> <li>5. Display a single horizontal line by pressing the ①key of the remote control unit.</li> <li>6. Turn the screen VR all the way to the left.</li> <li>7. Turn the screen VR gradually to the right from the left until either one of the red, blue or green colors appears faintly.</li> <li>8. Adjust the two colors which did not appear until the single horizontal line that is displayed becomes white using the ④ to ⑨ keys of the remote control unit.</li> <li>9. Turn the screen VR to where the single horizontal line glows faintly.</li> <li>10. Press the ② key to return to the regular screen.</li> </ol> <p>* The ③ EXIT key is the cancel key for the WHITE BALANCE.</p>														
<p><b>[LOW LIGHT] MODE</b></p> 																		
<p><b>REMOTE CONTROL UNIT</b></p> 																		
<p><b>WHITE BALANCE (High Light) Adjustment</b></p>	<p>Signal generator</p>		<p><b>G. DRIVE</b> <b>B. DRIVE</b></p>	<ol style="list-style-type: none"> <li>1. Receive a monoscope pattern signal.</li> <li>2. Select the 【HIGH LIGHT】 MODE in the SERVICE MENU.</li> <li>3. Set the initial setting value of G DRIVE and B DRIVE with the ④, ⑦ and ⑥, ⑨ keys of the remote control unit.</li> <li>4. Adjust the screen until it becomes white using the ④, ⑦, ⑥ and ⑨ keys of the remote control unit.</li> </ol> <p>* The ③ EXIT key is the cancel key for the WHITE BALANCE mode.</p>														
<p><b>[HIGH LIGHT] MODE</b></p>																		
																		
<p><b>Remote Control Unit Key Operation</b></p> <table border="1" data-bbox="965 1742 1396 2038"> <tr> <td>① key</td> <td>: H.LINE ON</td> </tr> <tr> <td>② key</td> <td>: H.LINE OFF</td> </tr> <tr> <td>③ key</td> <td>: EXIT</td> </tr> <tr> <td>④ key</td> <td>: G DRIVE ▲</td> </tr> <tr> <td>⑦ key</td> <td>: G DRIVE ▼</td> </tr> <tr> <td>⑥ key</td> <td>: B DRIVE ▲</td> </tr> <tr> <td>⑨ key</td> <td>: B DRIVE ▼</td> </tr> </table>					① key	: H.LINE ON	② key	: H.LINE OFF	③ key	: EXIT	④ key	: G DRIVE ▲	⑦ key	: G DRIVE ▼	⑥ key	: B DRIVE ▲	⑨ key	: B DRIVE ▼
① key	: H.LINE ON																	
② key	: H.LINE OFF																	
③ key	: EXIT																	
④ key	: G DRIVE ▲																	
⑦ key	: G DRIVE ▼																	
⑥ key	: B DRIVE ▲																	
⑨ key	: B DRIVE ▼																	

Item	Measuring instruments	Test point	Adjustment part	Description
<b>SUB BRIGHT Adjustment</b>			<b>No.1 BRIGHT</b>	<ol style="list-style-type: none"> <li>1. Receive a broadcast.</li> <li>2. Select No.1 BRIGHT of the PICTURE MODE.</li> <li>3. Set the initial setting value of the No.1 BRIGHT with the LEFT / RIGHT key of the MENU.</li> <li>4. If the brightness is not best with the initial setting value, make fine adjustment of the No.1 BRIGHT until you get the optimum brightness.</li> </ol>
<b>SUB CONTRAST Adjustment</b>			<b>No.2 PICTURE</b>	<ol style="list-style-type: none"> <li>1. Receive a broadcast.</li> <li>2. Select No.2 PICTURE of the PICTURE MODE.</li> <li>3. Set the initial setting value of the No.2 PICTURE with the LEFT / RIGHT key of the MENU.</li> <li>4. If the contrast is not best with the initial setting value, make fine adjustment of the No.2 PICTURE until you get the optimum contrast.</li> </ol>
<b>SUB COLOR adjustment</b>	Signal generator Oscilloscope Remote control unit	TP-R TP-E(↕) [CRT SOCKET PWB]	<b>No.3 COLOR</b>	<p><b>[ Method of adjustment without measuring instrument ]</b></p> <ol style="list-style-type: none"> <li>1. Receive a broadcast.</li> <li>2. Select "No.3 COLOR" of the PICTURE MODE.</li> <li>3. Set the initial setting value of the "No.3 COLOR" with the LEFT/RIGHT key of the MENU.</li> <li>4. If the color is not the best with the Initial setting value, make fine adjustment of the "No.3 COLOR" until you get the optimum color.</li> </ol> <hr/> <p><b>[ Method of adjustment using measuring instrument ]</b></p> <ol style="list-style-type: none"> <li>1. Input the full field color bar signal (75% white).</li> <li>2. Select "No.3 COLOR" to the PICTURE MODE.</li> <li>3. Set the initial setting value of the "No.3. COLOR" with the LEFT/RIGHT key of the MENU.</li> <li>4. Connect the oscilloscope between TP-R and TP-E.</li> <li>5. Adjust COLOR and bring the value of <b>(A)</b> in the illustration to the voltage <b>+20V</b> (<math>V_{W-R}</math>).</li> </ol>

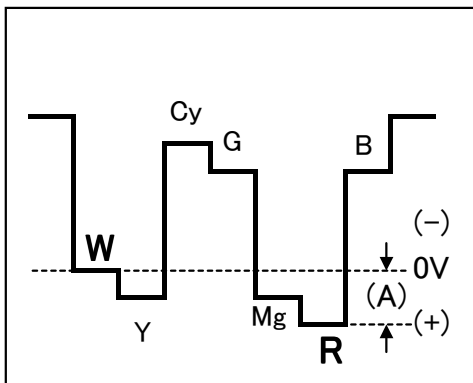

Application Model	COLOUR adjustment voltage
AV-27230/S	+20V
AV-27230/R	+20V

Item	Measuring instruments	Test point	Adjustment part	Description
SUB TINT adjustment	Signal generator Oscilloscope Remote control unit	TP-R TP-E(⚡) [CRT SOCKET PWB]	No.4 TINT	<p><b>[ Method of adjustment without measuring instrument ]</b></p> <ol style="list-style-type: none"> <li>1. Receive a broadcast.</li> <li>2. Select "No.4 TINT" of the PICTURE MODE.</li> <li>3. Set the initial setting value of the "No.4 TINT" with the LEFT/RIGHT key of the MENU.</li> <li>4. If the tint is not the best with the initial setting value, make fine adjustment of the "No.4 TINT" until you get the optimum tint.</li> </ol> <hr/> <p><b>[ Method of adjustment using measuring instrument ]</b></p> <ol style="list-style-type: none"> <li>1. Input the full field color bar signal (75% white).</li> <li>2. Select "No.4 TINT" to the PICTURE MODE.</li> <li>3. Set the initial setting value of the "No.4 TINT" with the LEFT/RIGHT key to the MENU.</li> <li>4. Connect the oscilloscope between TP-R and TP-E.</li> <li>5. Adjust TINT and bring the value of <b>(B)</b> in the illustration to the voltage <b>+17V</b> (<math>V_{W-Y}</math>).</li> </ol>

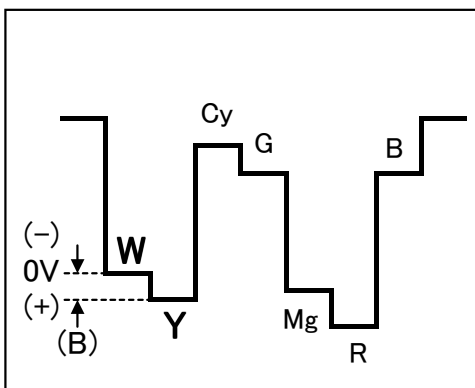

Application Model	COLOUR adjustment voltage
AV-27230/S	+17V
AV-27230/R	+17V

## ADJUSTMENT OF MTS CIRCUIT

Item	Measuring instrument	Test point	Adjustment part	Description
MTS INPUT LEVEL check			No.1 IN LEVEL	<ol style="list-style-type: none"> <li>1. Select the "No.1 IN LEVEL" of the SOUND MODE.</li> <li>2. Verify that the "No.1 IN LEVEL" is set at its initial setting value.</li> </ol>
MTS STEREO VCO adjustment	Signal generator Frequency counter	R OUT [AUDIO OUT]	No.2 FH MON. No.3 ST VCO	<ol style="list-style-type: none"> <li>1. Receive a RF signal (nonmodulated sound signal) from the antenna terminal.</li> <li>2. Select the "No.2 FH MON." of SOUND MODE, and change the setting value from 0 to 1.</li> <li>3. Connect the Frequency Counter to R OUT RCA pin of the AUDIO OUT.</li> <li>4. Select the "No.3 ST VCO".</li> <li>5. Set the initial setting value of the "No.3 ST VCO" with the LEFT/RIGHT key of the menu.</li> <li>6. Adjust the "No.3 ST VCO" so that the Frequency Counter will display <math>15.73\text{kHz} \pm 0.1\text{kHz}</math>.</li> <li>7. Select the "No.2 FH MON." of the SOUND MODE, and reset the setting value from 1 to 0.</li> </ol>
MTS SAP VCO adjustment	Signal generator Frequency counter	<b>[MPX]</b> Connector <b>[4]</b> pin SDA <b>[3]</b> pin GND R OUT [AUDIO OUT]	No.8 5FH MON. No.9 SAP VCO	<ol style="list-style-type: none"> <li>1. Receive a RF signal (non modulated sound signal) from the antenna terminal.</li> <li>2. Connect between pin <b>[4]</b> of <b>[MPX]</b> connector and GND (Pin <b>[3]</b> of <b>[MPX]</b> connector) through <math>1\text{M}\Omega</math> Resistor.</li> <li>3. Select the "No.8 5FH MON." of the SOUND MODE, and reset the setting value from 0 to 1.</li> <li>4. Connect the Frequency Counter to R OUT RCA pin of the AUDIO OUT.</li> <li>5. Select the "No.9 SAP VCO".</li> <li>6. Set the initial setting value of "No.9 SAP VCO" with the LEFT/RIGHT key of the menu.</li> <li>7. Adjust the "No.9 SAP VCO" so that the Frequency Counter will display <math>78.67\text{kHz} \pm 0.5\text{kHz}</math>.</li> <li>8. Select the "No.8 5FH MON." of the SOUND MODE, and reset the setting value from 1 to 0.</li> </ol>



Item	Measuring instrument	Test point	Adjustment part	Description
<b>MTS FILTER check</b>			<b>No.5 FILTER</b>	1. Select the "No.5 FILTER" of the SOUND MODE. 2. Verify that the "No.5 FILTER" is set at its initial setting value.
<b>MTS SEPARATION adjustment</b>	TV audio multiplex signal generator  Oscilloscope	L OUT R OUT [AUDIO OUT]	<b>No.6 LOW SEP.</b>  <b>No.7 HI SEP.</b>	1. Input a stereo L signal (300Hz) from the TV audio multiplex signal generator to the antenna terminal. 2. Connect an oscilloscope to L OUT RCA pin of the AUDIO OUT, and display one cycle portion of the 300Hz signal. 3. Change the connection of the oscilloscope to R OUT RCA pin of the AUDIO OUT, and enlarge the voltage axis. 4. Select the "No.6 LOW SEP." of the SOUND MODE. 5. Set the initial setting value of the "No.6 LOW SEP." with the LEFT/RIGHT key of the menu. 6. Adjust the "No.6 LOW SEP." so that the stroke element of the 300Hz signal will become minimum. 7. Change the signal to 3kHz, and similarly adjust the "No.7 HI SEP.".

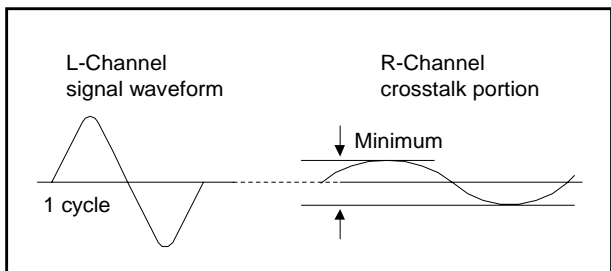

# HOW TO CHECK THE HIGH VOLTAGE HOLD DOWN CIRCUIT

## 1. HIGH VOLTAGE HOLD DOWN CIRCUIT

After repairing the high voltage hold down circuit shown in Fig. 1.  
This circuit shall be checked to operate correctly.

## 2. CHECKING OF THE HIGH VOLTAGE HOLD DOWN CIRCUIT

- (1) Turn the power switch to on.
- (2) As shown in Fig. 1, set the resistor between  X connector  1 and  3 .
- (3) Make sure that the screen picture disappears.
- (4) Temporarily unplug the power plug.
- (5) Remove the resistor replaced  X connector  1 and  3 .
- (6) Again plug the power plug, make sure that the normal picture is displayed on the screen.

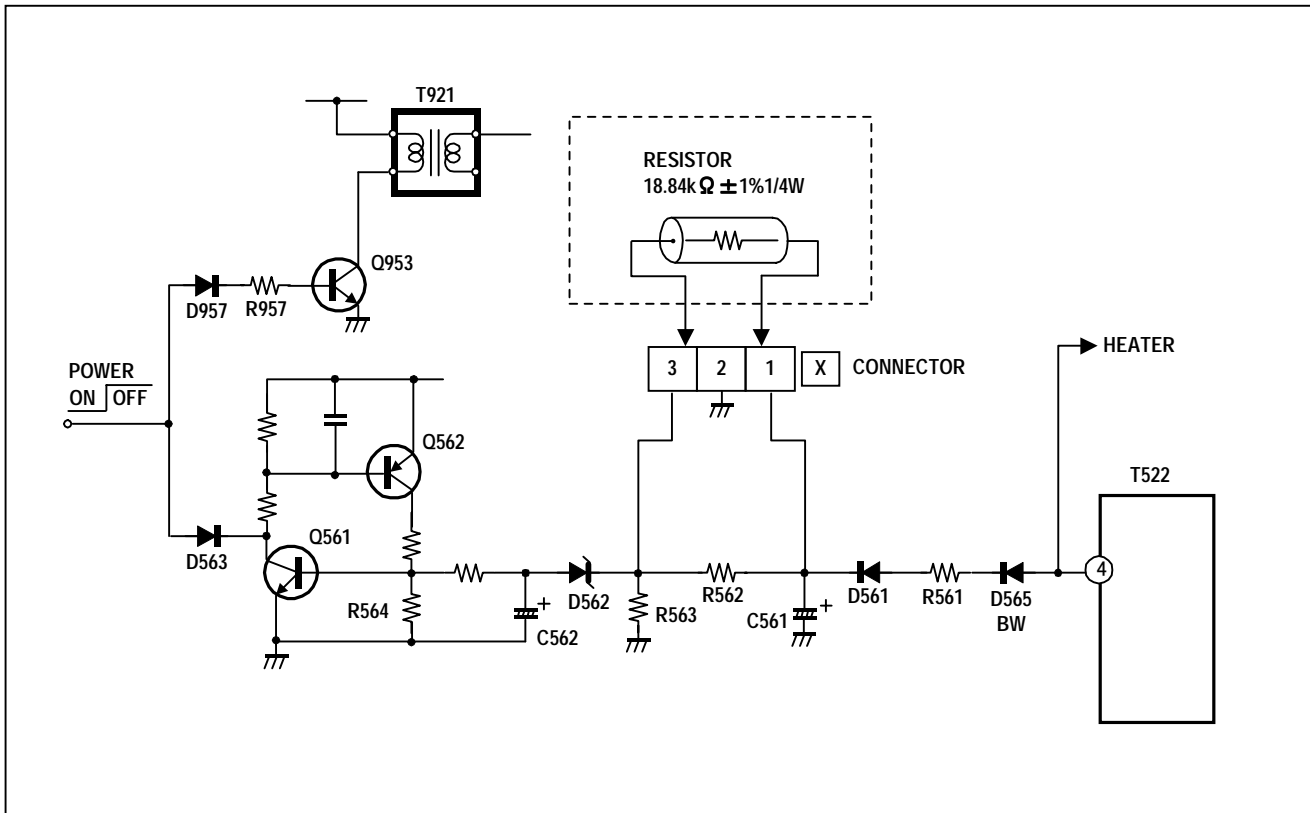

Fig. 1

## SELF CHECK FUNCTIONS

### 1. Outline

This model has self check functions given below. When a malfunction has been detected, the POWER is turned off and the LED flashes to inform of the failure . The malfunction is detected by the signal input state of the control line connected to the microcomputer.

### 2. Self check items

Check item	Details of detection	Method of detection	State of malfunction
CRT NECK protector Also detected if the power supply line output from the HVT (High voltage Transformer) has shorted with the ground.	When the vertical circuit S-correction capacitor C427 is shorted, detect the potential drop of the C427, and prevent the burn damage to the CRT NECK. (Grounding of shorting of the power supply output from the HVT to the vertical circuit, and the small signal power supply is also detected.)	The microcomputer detects at 1 second intervals. If NG is detected for more than 1 ms, a malfunction is interpreted.	When a malfunction has been detected, the POWER is turned off. While the POWER is being turned off , the power key of the remote controller is not operational until the power code is taken out and put in again.

### 3. Self check indicating function

The self-check function begins detection about 5 seconds after power is supplied.

In the event a malfunction is detected, the power is cut off immediately.

At this time, the ON-TIMER LED flashes to inform of the malfunction.

#### [ON-TIMER LED indication]

The ON-TIMER LED flashes at 0.5 seconds intervals.

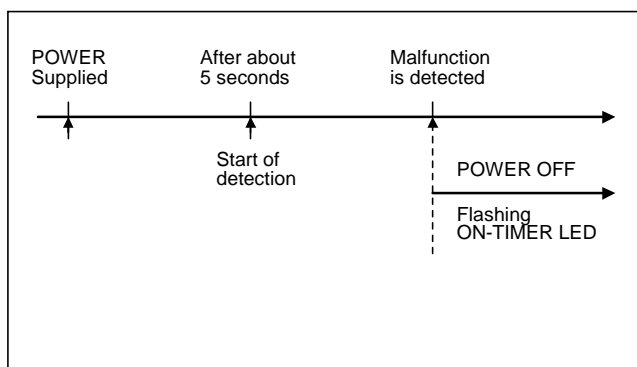

## REPLACEMENT OF CHIP COMPONENT

### ■ CAUTIONS

1. Avoid heating for more than 3 seconds.
2. Do not rub the electrodes and the resist parts of the pattern.
3. When removing a chip part, melt the solder adequately.
4. Do not reuse a chip part after removing it.

### ■ SOLDERING IRON

1. Use a high insulation soldering iron with a thin pointed end of it.
2. A 30w soldering iron is recommended for easily removing parts.

### ■ REPLACEMENT STEPS

#### 1. How to remove Chip parts

##### ◆ Resistors, capacitors, etc.

- (1) As shown in the figure, push the part with tweezers and alternately melt the solder at each end.

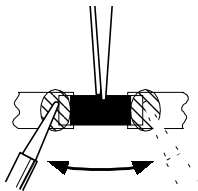

- (2) Shift with tweezers and remove the chip part.

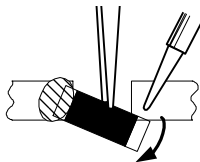

##### ◆ Transistors, diodes, variable resistors, etc.

- (1) Apply extra solder to each lead.

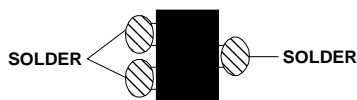

- (2) As shown in the figure, push the part with tweezers and alternately melt the solder at each lead. Shift and remove the chip part.

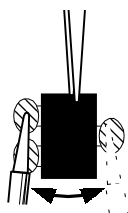

Note : After removing the part, remove remaining solder from the pattern.

#### 2. How to install Chip parts

##### ◆ Resistors, capacitors, etc.

- (1) Apply solder to the pattern as indicated in the figure.

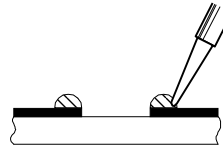

- (2) Grasp the chip part with tweezers and place it on the solder. Then heat and melt the solder at both ends of the chip part.

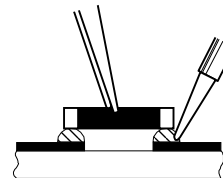

##### ◆ Transistors, diodes, variable resistors, etc.

- (1) Apply solder to the pattern as indicated in the figure.
- (2) Grasp the chip part with tweezers and place it on the solder.
- (3) First solder lead **A** as indicated in the figure.

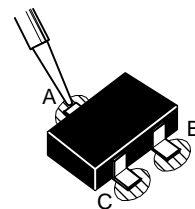

- (4) Then solder leads **B** and **C**.

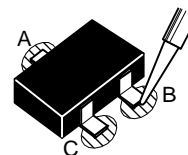



## JVC SERVICE & ENGINEERING COMPANY OF AMERICA

### DIVISION OF JVC AMERICAS CORP.

<b>Head office :</b>	1700 Valley Road, Wayne, New Jersey 07470	(973)315-5000
<b>East Coast :</b>	10 New Maple Avenue, Pine Brook, New Jersey 07058	(973)396-1000
<b>Midwest :</b>	705 Enterprise St. Aurora, Illinois 60504	(630)851-7855
<b>West Coast :</b>	5665 Corporate Avenue, Cypress, California 90630	(714)229-8011
<b>Southwest :</b>	10700 Hammerly, Suite 105, Houston, Texas 77043	(713)935-9331
<b>Hawaii :</b>	2969 Mapunapuna Place, Honolulu, Hawaii 96819	(808)833-5828
<b>Southeast :</b>	1500 Lakes Parkway, Lawrenceville, Georgia 30243	(770)339-2582

### JVC CANADA INC.

<b>Head office :</b>	21 Finchdene Square Scarborough, Ontario M1X 1A7	(416)293-1311
<b>Vancouver :</b>	13040 Worster Court Richmond B.C. V6V 2B3	(604)270-1311

# JVC<sup>®</sup>